

2.5G-DWDM-80

2.5Gbps Single Mode DWDM SFP Transceiver

PRODUCT FEATURES

- Transceiver unit with independent
DWDM DFB Laser diode transmitter
APD photodiode receiver
- Compliant with DWDM SFP MSA
- SFF-8472 with duplex LC receptacle
- Hot-pluggable
- Metal enclosure for lower EMI
- 3.3V Single power supply
- 100GHz ITU Grid, C Band
- Wavelength controlled within $\pm 0.1\text{nm}$ over life and temperature
- Digital diagnostic monitoring
- 80 km with 9/125 μm single mode fiber (SMF) of maximum interconnect distances
- Case operating temperature: 0°C to $+70^{\circ}\text{C}$

APPLICATIONS

- C Band DWDM networks
- SONET/SDH networks
- Fiber channel
- Gigabit Ethernet

PRODUCT DESCRIPTION

Sate Optics's 2.5G-DWDM-80 Small Form Factor Pluggable (SFP) transceivers are compatible with the Small Form Factor Pluggable Multi-Sourcing Agreement (MSA) and SFF-8472. The transceiver consists of five sections: the LD driver, the limiting amplifier, the digital diagnostic monitor, the DFB laser and the APD .The module data link up to 80KM in 9/125um single mode fiber. It offers a simple and convenient way to interface PCBs to single mode fiber optic cables in Dense Wavelength Division Multiplexing (DWDM) applications. It is a high performance, cost effective module for serial optical data communication applications.

The optical output can be disabled by a TTL logic high-level input of Tx Disable, and the system also can disable the module via I2C. Tx Fault is provided to indicate that degradation of the laser. Loss of signal (LOS) output is provided to indicate the loss of an input optical signal of receiver or the link status with partner. The system can also get the LOS (or Link)/Disable/Fault information via I2C register access.

I. Pin Descriptions

Pin	Symbol	Name/Description	Ref.
1	V _{EET}	Transmitter Ground (Common with Receiver Ground)	1
2	T _{FAULT}	Transmitter Fault.	
3	T _{DIS}	Transmitter Disable. Laser output disabled on high or open.	2
4	MOD_DEF(2)	Module Definition 2. Data line for Serial ID.	3
5	MOD_DEF(1)	Module Definition 1. Clock line for Serial ID.	3
6	MOD_DEF(0)	Module Definition 0. Grounded within the module.	3
7	Rate Select	No connection required	4
8	LOS	Loss of Signal indication. Logic 0 indicates normal operation.	5
9	V _{EER}	Receiver Ground (Common with Transmitter Ground)	1
10	V _{EER}	Receiver Ground (Common with Transmitter Ground)	1
11	V _{EER}	Receiver Ground (Common with Transmitter Ground)	1
12	RD-	Receiver Inverted DATA out. AC Coupled	
13	RD+	Receiver Non-inverted DATA out. AC Coupled	
14	V _{EER}	Receiver Ground (Common with Transmitter Ground)	1
15	V _{CCR}	Receiver Power Supply	
16	V _{CCT}	Transmitter Power Supply	
17	V _{EET}	Transmitter Ground (Common with Receiver Ground)	1
18	TD+	Transmitter Non-Inverted DATA in. AC Coupled.	
19	TD-	Transmitter Inverted DATA in. AC Coupled.	
20	V _{EET}	Transmitter Ground (Common with Receiver Ground)	1

Notes:

1. Circuit ground is internally isolated from chassis ground.
2. Laser output disabled on $T_{DIS} > 2.0V$ or open, enabled on $T_{DIS} < 0.8V$.
3. Should be pulled up with 4.7k - 10kohms on host board to a voltage between 2.0V and 3.6V. MOD_DEF (0) pulls line low to indicate module is plugged in.
4. This is an optional input used to control the receiver bandwidth for compatibility with multiple data rates (most likely Fiber Channel 1x and 2x Rates). If implemented, the input will be internally pulled down with $> 30k\Omega$ resistor. The input states are:
 - Low (0 – 0.8V): Reduced Bandwidth
 - ($>0.8, < 2.0V$): Undefined
 - High (2.0 – 3.465V): Full Bandwidth
 - Open: Reduced Bandwidth
5. LOS is open collector output should be pulled up with 4.7k - 10kohms on host board to a voltage between 2.0V and 3.6V. Logic 0 indicates normal operation; logic 1 indicates loss of signal.

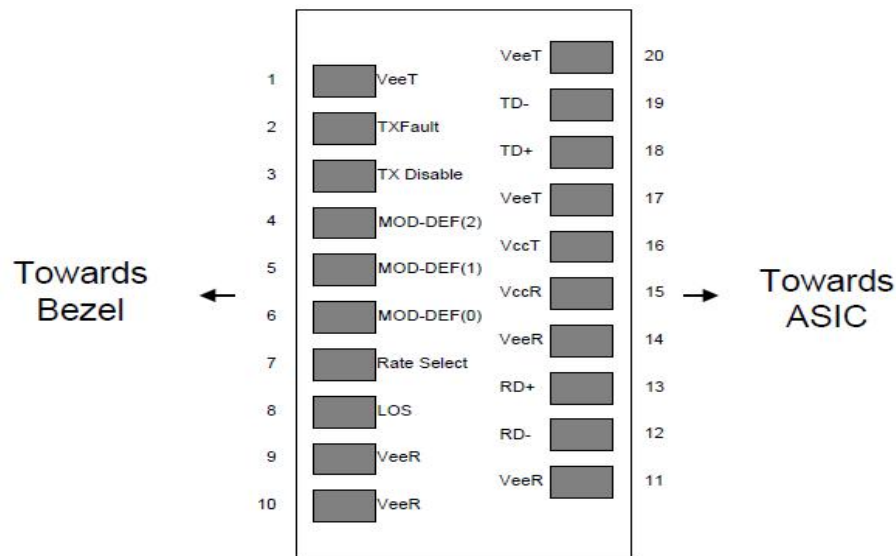

Figure2. Pin out of Connector Block on Host Board

II. Absolute Maximum Ratings

Parameter	Symbol	Min.	Typ.	Max.	Unit	Note
Storage Temperature	Ts	-40		85	°C	
Storage Ambient Humidity	HA	5		95	%	
Power Supply Voltage	VCC	-0.5		4	V	
Signal Input Voltage		-0.3		Vcc+0.3	V	
Receiver Damage Threshold		+5			dBm	

III. Recommended Operating Conditions

Parameter	Symbol	Min.	Typ.	Max.	Unit	Note	
Case Operating Temperature	T _{case}	0		70	°C		
Ambient Humidity	HA	5		70	%	Non-condensing	
Power Supply Voltage	V _{CC}	3.13	3.3	3.47	V		
Power Supply Current	I _{CC}			300	mA		
Power Supply Noise Rejection				100	mVp-p	100Hz to 1MHz	
Data Rate			2500/2500		Mbps	TX Rate/RX Rate	
Transmission Distance				80	KM		
Coupled Fiber		Single mode fiber					9/125um SMF

IV. Specification of Transmitter

Parameter	Symbol	Min.	Typ.	Max.	Unit	Note
Center Wavelength Spacing			100		GHz	
Center Wavelength	λ	X-100	X	X+100	pm	Note (1)
Average Output Power	P _{OUT}	0		4	dBm	
Extinction Ratio	ER	8.2			dB	
Side Mode Suppression Ratio	SMSR	30			dB	
Spectrum Bandwidth(-20dB)	σ			0.3	nm	
Transmitter OFF Output Power	P _{OFF}			-45	dBm	
Differential Line Input Impedance	R _{IN}	90	100	110	Ohm	
Output Eye Mask	Compliant with ITU recommendation G.957					Note (2)

Note (1): X = specified ITU center wavelength. (To See “Ordering Information”)

Note (2): Transmitter eye mask definition.

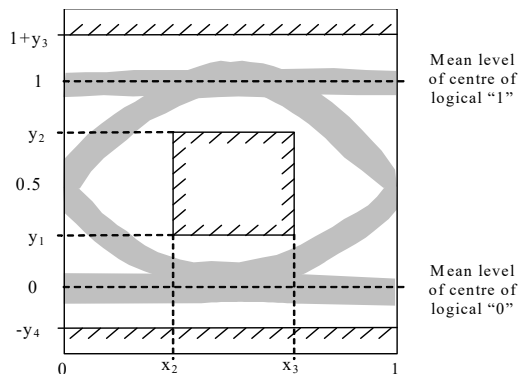

$x_3 - x_2$	0.2
y_1	0.25
y_2	0.75
y_3	0.25
y_4	0.25

V. Specification of Receiver

Parameter	Symbol	Min.	Typ.	Max.	Unit	Note
Input Optical Wavelength	λ_{IN}	1270		1610	nm	APD
Receiver Sensitivity	P_{IN}			-28	dBm	Note (1)
Input Saturation Power (Overload)	P_{SAT}	-10			dBm	
Los Of Signal Assert	P_A			-31	dBm	
Los Of Signal De-assert	P_D	-40			dBm	Note (2)
LOS Hysteresis	P_A-P_D	0.5	2	6	dB	

Note (1): Measured with Light source 1550nm, ER=9dB; BER = $<10^{-12}$ @PRBS=2²³-1 NRZ

Note (2): When LOS de-asserted, the RX data+/- output is High-level (fixed)

VI. Electrical Interface Characteristics

Parameter	Symbol	Min.	Typ.	Max.	Unit	Note
Transmitter						
Total Supply Current	I_{CC}			A	mA	Note (1)
Transmitter Disable Input-High	V_{DISH}	2		$V_{CC}+0.3$	V	
Transmitter Disable Input-Low	V_{DISL}	0		0.8	V	
Transmitter Fault Input-High	V_{DISL}	2		$V_{CC}+0.3$	V	
Transmitter Fault Input-Low	V_{TxFH}	0		0.8	V	
Receiver						
Total Supply Current	I_{CC}			B	mA	Note (1)
LOSS Output Voltage-High	V_{LOSH}	2		$V_{CC}+0.3$	V	LVTTL
LOSS Output Voltage-Low	V_{LOSL}	0		0.8	V	

Note (1): A (TX) + B (RX) = 300mA (Not include termination circuit)

VII. Digital Diagnostic Functions

Sate Optics 2.5G-DWDM-80 transceivers support the 2-wire serial communication protocol as defined in the SFP MSA. It is very closely related to the E2PROM defined in the GBIC standard, with the same electrical specifications.

The standard SFP serial ID provides access to identification information that describes the transceiver's capabilities, standard interfaces, manufacturer, and other information.

Additionally, Sate Optics SFP transceivers provide a unique enhanced digital diagnostic monitoring interface, which allows real-time access to device operating parameters such as transceiver temperature, laser bias current, transmitted optical power, received optical power and transceiver supply voltage. It also defines a sophisticated system of alarm and warning flags, which alerts end-users when particular operating parameters are outside of a factory set normal range.

The SFP MSA defines a 256-byte memory map in E2PROM that is accessible over a 2-wire serial interface at the 8 bit address 1010000X (A0h). The digital diagnostic monitoring interface makes use of the 8 bit address 1010001X (A2h), so the originally defined serial ID memory map remains unchanged. The interface is identical to, and is thus fully backward compatible with both the GBIC Specification and the SFP Multi Source Agreement.

The operating and diagnostics information is monitored and reported by a Digital Diagnostics Transceiver Controller (DDTC) inside the transceiver, which is accessed through a 2-wire serial interface. When the serial protocol is activated, the serial clock signal (SCL, Mod Def 1) is generated by the host. The positive edge clocks data into the SFP transceiver into those segments of the E2PROM that are not write-protected. The negative edge clocks data from the SFP transceiver. The serial data signal (SDA, Mod Def 2) is bi-directional for serial data transfer. The host uses SDA in conjunction with SCL to mark the start and end of serial protocol activation. The memories are organized as a series of 8-bit data words that can be addressed individually or sequentially.

Digital diagnostics for the 2.5G-DWDM-80 are internally calibrated by default. ◦

VIII. Recommend Circuit Schematic

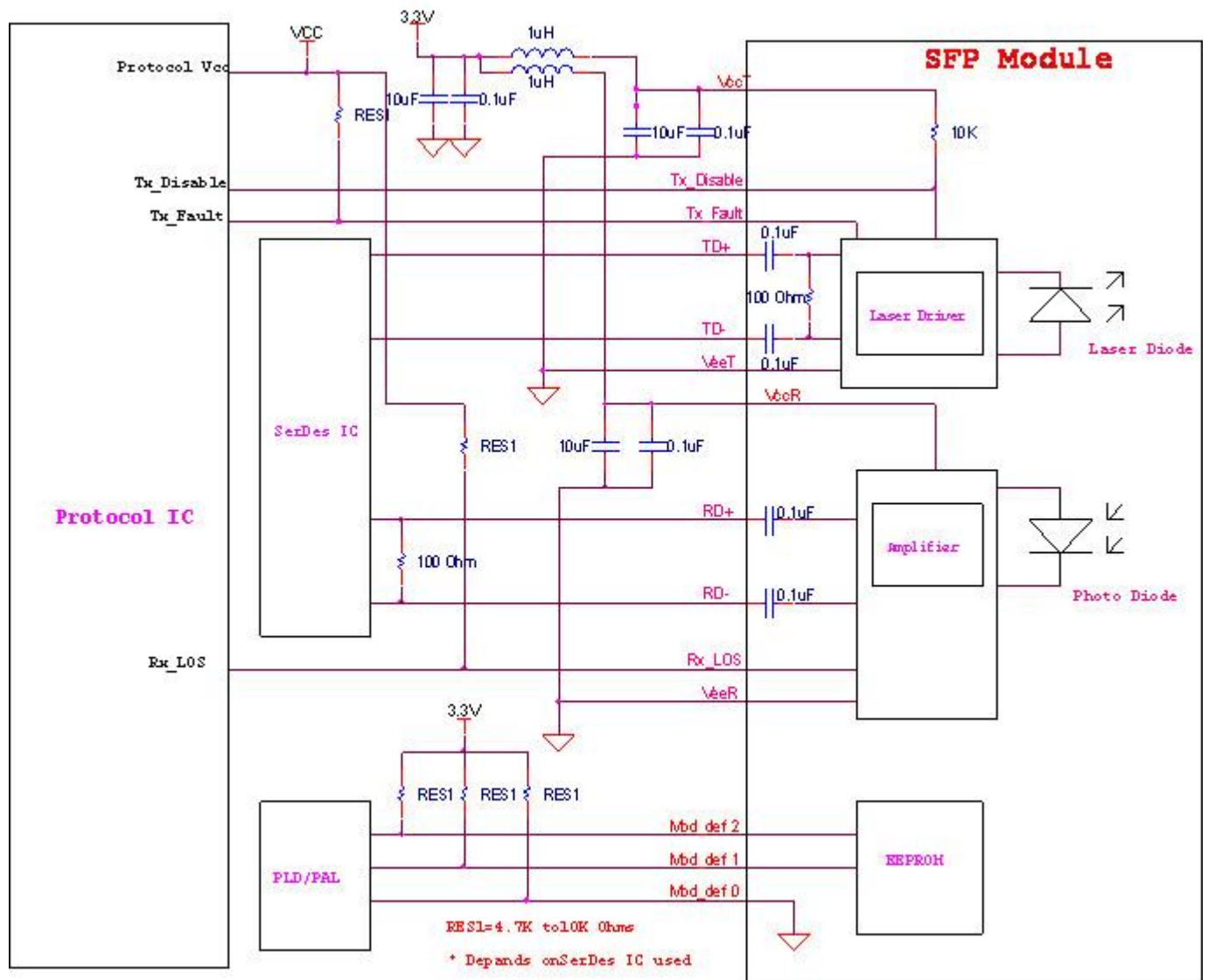

IX. Mechanical Specifications (Unit: mm)

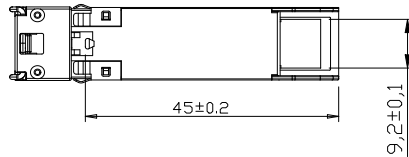
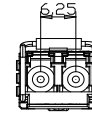
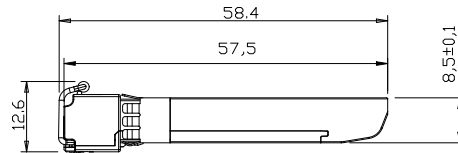
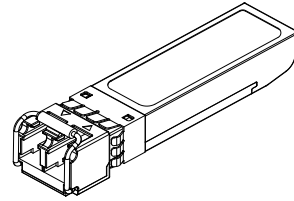
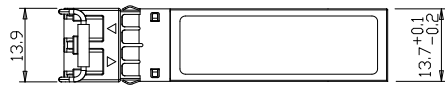

Units in mm

X. Ordering Information

Code	Frequency (THz)	Center Wavelength(nm)	Code	Frequency (THz)	Center Wavelength(nm)
C17	191.7	1563.86	C40	194.0	1545.32
C18	191.8	1563.05	C41	194.1	1544.53
C19	191.9	1562.23	C42	194.2	1543.73
C20	192.0	1561.42	C43	194.3	1542.94
C21	192.1	1560.61	C44	194.4	1542.14
C22	192.2	1559.79	C45	194.5	1541.35
C23	192.3	1558.98	C46	194.6	1540.56
C24	192.4	1558.17	C47	194.7	1539.77
C25	192.5	1557.36	C48	194.8	1538.98
C26	192.6	1556.55	C49	194.9	1538.19
C27	192.7	1555.75	C50	195.0	1537.40
C28	192.8	1554.94	C51	195.1	1536.61
C29	192.9	1554.13	C52	195.2	1535.82
C30	193.0	1553.33	C53	195.3	1535.04
C31	193.1	1552.52	C54	195.4	1534.25
C32	193.2	1551.72	C55	195.5	1533.47
C33	193.3	1550.92	C56	195.6	1532.68
C34	193.4	1550.12	C57	195.7	1531.90
C35	193.5	1549.32	C58	195.8	1531.12
C36	193.6	1548.51	C59	195.9	1530.33
C37	193.7	1547.72	C60	196.0	1529.55
C38	193.8	1546.92	C61	196.1	1528.77
C39	193.9	1546.12			

Appendix A. Document Revision

Version No.	Date	Description
1.0	2010-09-12	Preliminary datasheet
2.0	2011-10-28	Update company's logo and format